

## TO-220AC Plastic-Encapsulate Diode

HYPERFAST RECTIFIER, FRED

### Features:

- Ultrafast Recovery Times and Low Recovery Loss
- Low Forward Voltage
- Low Reverse Leakage Current

### Application:

Specifically designed to improve efficiency of PFC and output rectification stages of EV / HEV battery charging stations, booster stage of solar inverters and UPS applications, these devices are perfectly matched to operate with MOSFETs or high speed IGBTs.

TO-220AC

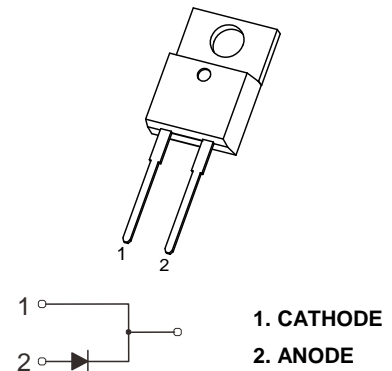

### MAIN CHARACTERISTICS

$I_O$	<b>15A</b>
$V_{RRM}$	<b>600V</b>
$T_{rr}$	<b>18ns</b>
$T_j$	<b>175°C</b>
$V_{F(typ)}$	<b>1.10V(@<math>T_j=150^\circ\text{C}</math>)</b>

### MARKING

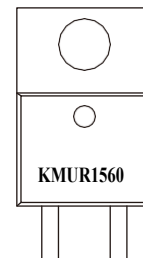

### MAXIMUM RATINGS ( $T_c=25^\circ\text{C}$ unless otherwise noted )

Symbol	Parameter	KMUR1560	Unit
$V_{RRM}$	Peak Repetitive Reverse Voltage	600	V
$V_R$	DC Blocking Voltage		
$I_{F(AV)}$	Average Forward Current( $T_c=125^\circ\text{C}$ )	15	A
$I_{F(RMS)}$	RMS Forward Current( $T_c=125^\circ\text{C}$ )	21	A
$I_{FSM}$	Non-Repetitive Surge Forward Current (8.3ms)	224	A
$P_D$	Power dissipation	100	W
$R_{\theta JC}$	Thermal Resistance From Junction to Case	1.5	$^\circ\text{C}/\text{W}$
$T_j$	Operating Junction Temperature Range	-55 ~ +175	$^\circ\text{C}$
$T_{stg}$	Storage Temperature Range	-55 ~ +175	$^\circ\text{C}$

## Typical Characteristics

### ELECTRICAL CHARACTERISTICS ( $T_c=25^\circ\text{C}$ unless otherwise specified)

Symbol	Parameter	Test Conditions	Min.	Typ.	Max.	Unit
$V_{(BR)}$	Reverse Voltage	$I_R=100\mu\text{A}$	600			V
$I_R$	Reverse Current	$V_R=600\text{V}$	$T_j=25^\circ\text{C}$		10	$\mu\text{A}$
			$T_j=150^\circ\text{C}$		800	$\mu\text{A}$
$V_F$	Forward Voltage	$I_F=15\text{A}$	$T_j=25^\circ\text{C}$	1.35	1.50	V
			$T_j=150^\circ\text{C}$	1.10		V
$C_{tot}$	Total Capacitance	$V_R=200\text{V}, f=1\text{MHz}$		24		pF
trr	Reverse Recovery time	$I_F=0.5\text{A}, I_R=1\text{A}, I_{rr}=0.25\text{A}$		23		ns
		$I_F=1\text{A}, V_R=30\text{V}, di_F/dt=200\text{A}/\mu\text{s}$		18		ns

### ELECTRICAL CHARACTERISTICS ( $T_c=25^\circ\text{C}$ unless otherwise specified)

Symbol	Parameter	Test Conditions	Min.	Typ.	Max.	Unit
trr	Reverse Recovery Time	$I_F=15\text{A}, V_R=400\text{V}, di_F/dt=200\text{A}/\mu\text{s}$		31		ns
$I_{RRM}$	Max. Reverse Recovery Current			2.7		A
Qrr	Reverse Recovery Charge			49		nC
trr	Reverse Recovery Time	$I_F=15\text{A}, V_R=400\text{V}, di_F/dt=200\text{A}/\mu\text{s}, T_j=125^\circ\text{C}$		74		ns
$I_{RRM}$	Max. Reverse Recovery Current			6.2		A
Qrr	Reverse Recovery Charge			269		nC
trr	Reverse Recovery Time	$I_F=15\text{A}, V_R=400\text{V}, di_F/dt=600\text{A}/\mu\text{s}, T_j=125^\circ\text{C}$		41		ns
$I_{RRM}$	Max. Reverse Recovery Current			17		A
Qrr	Reverse Recovery Charge			374		nC

## Typical Characteristics

Forward Characteristics

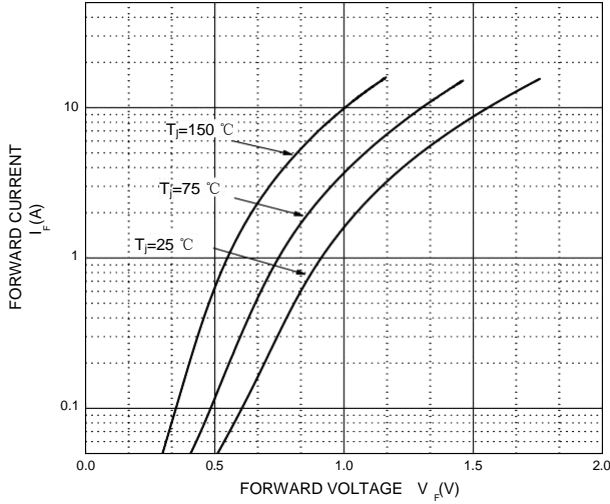

Reverse Characteristics

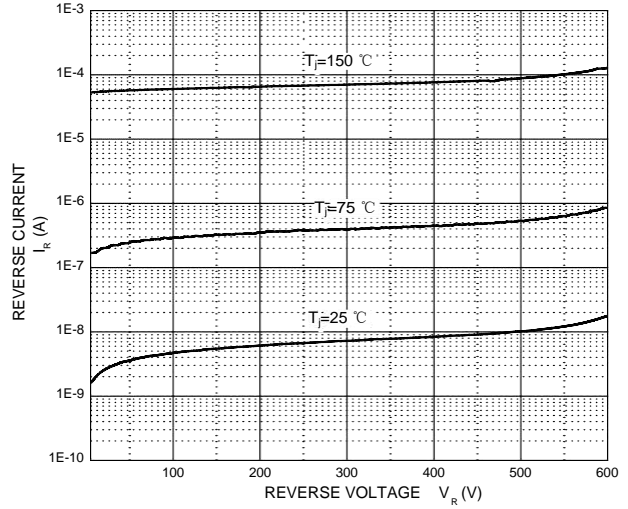

Capacitance Characteristics Per Diode

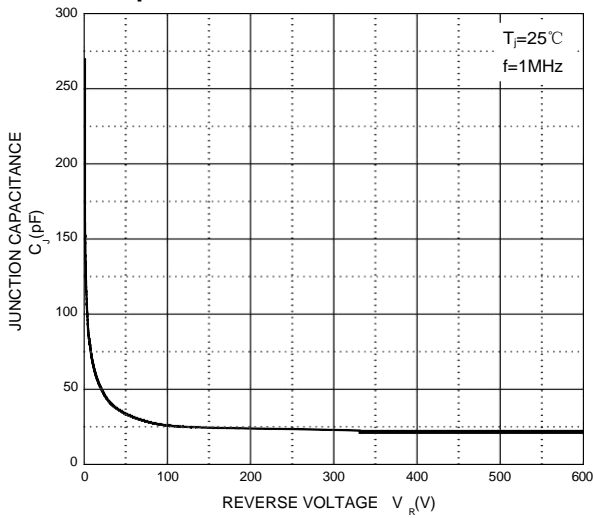

Recovery Current vs.  $di_F/dt$

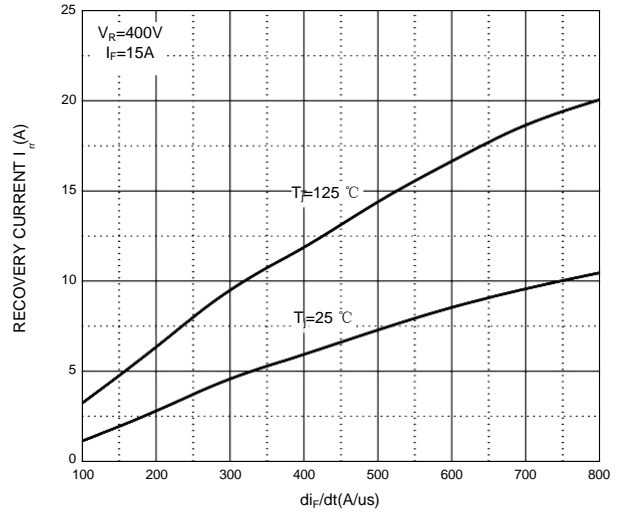

Reverse Recovery Time vs.  $di_F/dt$

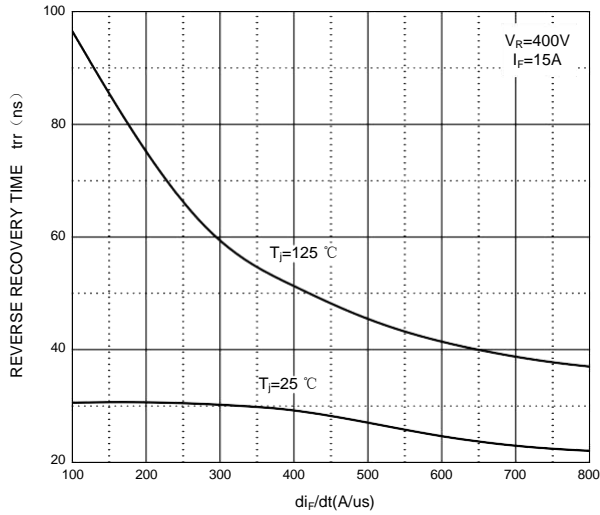

Stored Charge vs.  $di_F/dt$

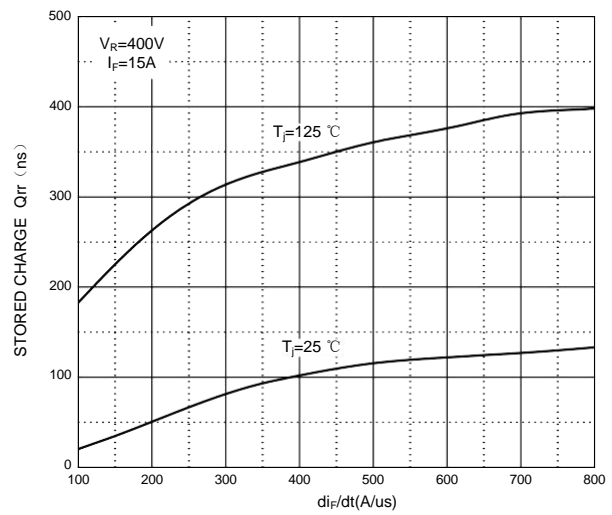

## Typical Characteristics

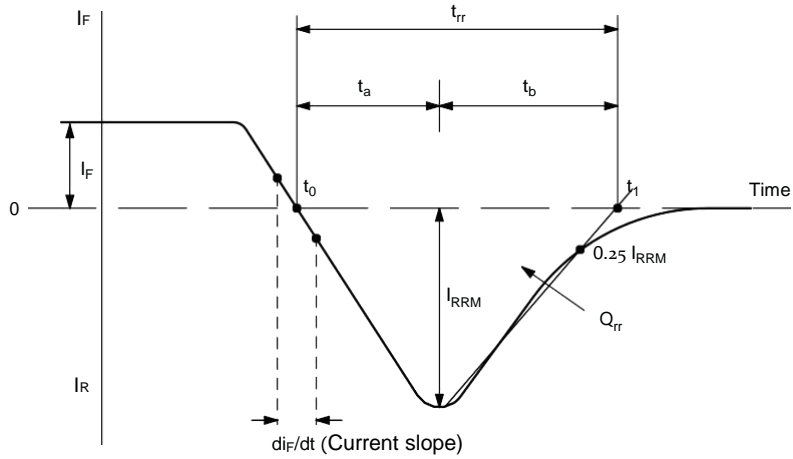

Reverse Recovery Waveform and Definitions

MUR15H60 Transient Thermal Impedance, Junction-Case

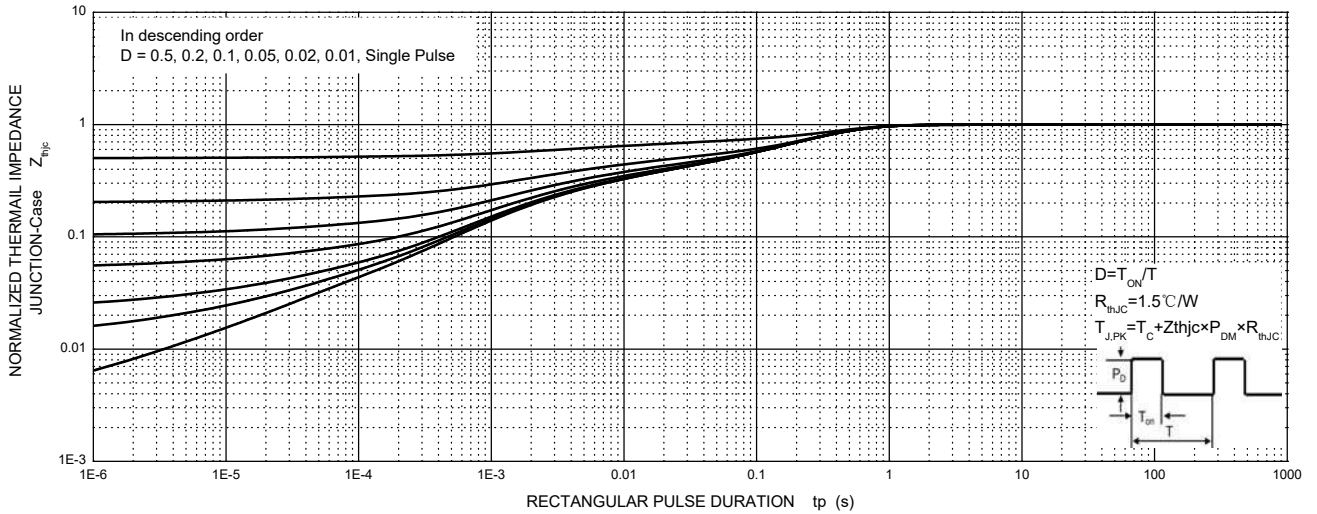

TO-220AC Package Outline Dimensions

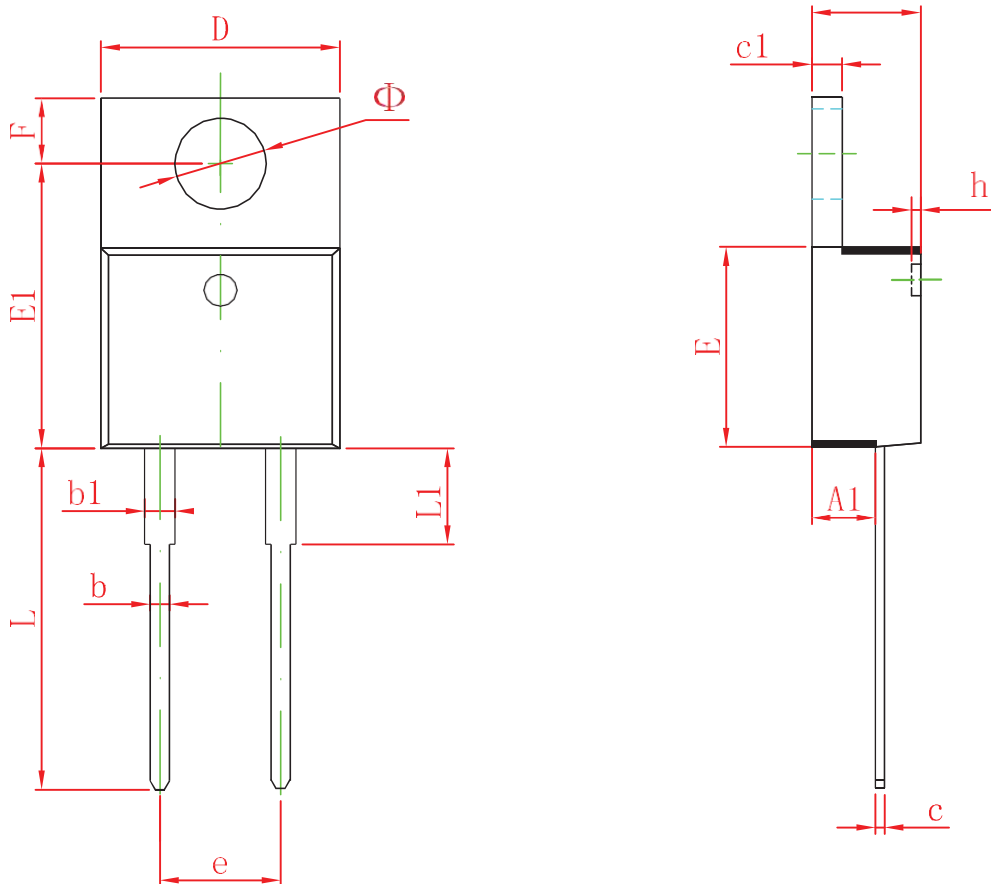

Symbol			Dimensions In Inches	
	Min	Max	Min	Max
A	4.450	4.750	0.175	0.187
	2.520	2.820	0.099	0.111
b	0.710	0.910	0.028	0.036
b1	1.170	1.370	0.046	0.054
c	0.300	0.500	0.012	0.020
c1	1.170	1.370	0.046	0.054
D	9.830	10.330	0.387	0.407
E	8.500	8.900	0.335	0.350
E1	12.050	12.650	0.474	0.498
e	5.080 TYP		0.200 TYP	
F	2.540	2.940	0.100	0.116
h	0.100 TYP		0.004 TYP	
L	13.300	13.800	0.523	0.543
L1	3.540	3.940	0.139	0.155
$\Phi$	3.735	3.935	0.147	0.155