

SOD-123FL Plastic-Encapsulate Diodes

Low VF Schottky Rectifier Diodes

Features:

- $I_{F(AV)}$ 2A
- V_{RRM} 20V-100V
- High surge current capability
- Polarity: Color band denotes cathode

Applications:

- Rectifier

Marking

- KDSK22L-KDSK210L:K22L-K210L

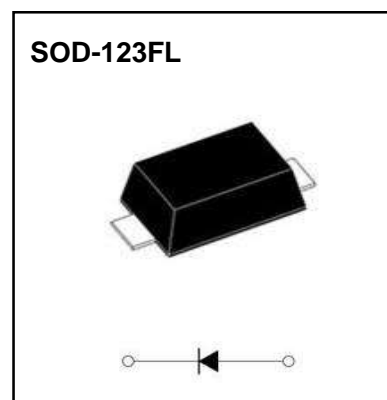

Limiting Values (Absolute Maximum Rating)

Item	Symbol	Unit	Test Conditions	KDSK						
				22L	23L	24L	25L	26L	28L	210L
Repetitive Peak Reverse Voltage	V_{RRM}	V		20	30	40	50	60	80	100
Maximum RMS Voltage	V_{RMS}	V		14	21	28	35	42	56	70
Maximum DC Blocking Voltage	V_{DC}	V		20	30	40	50	60	80	100
Average Forward Current	$I_{F(AV)}$	A	60Hz Half-sine wave , Resistance load , $T_L=(Fig.1)$	2.0						
Surge(Non-repetitive)Forward Current	I_{FSM}	A	60Hz Half-sine wave , 1 cycle , $T_a=25^{\circ}C$	50						
Junction Temperature	T_J	$^{\circ}C$		-55~+125			-55~+150			
Storage Temperature	T_{STG}	$^{\circ}C$		-55 ~ +150						

Electrical Characteristics (T=25 $^{\circ}C$ Unless otherwise specified)

Item	Symbol	Unit	Test Condition	KDSK							
				22L	23L	24L	25L	26L	28L	210L	
Peak Forward Voltage	V_{FM}	V	$I_{FM}=2.0A$	0.42		0.58		0.72			
Peak Reverse Current	I_{RRM1}	mA	$V_{RM}=V_{RRM}$	$T_a=25^{\circ}C$			0.5		0.1		
	I_{RRM2}			$T_a=100^{\circ}C$			10		5.0		
Thermal Resistance(Typical)	$R_{\theta J-A}$	$^{\circ}C/W$	Between junction and ambient	75							
	$R_{\theta J-L}$		Between junction and terminal	17							

Notes:

Thermal resistance from junction to ambient and from junction to lead mounted on P.C.B. with 0.2" x 0.2" (5.0 mm x 5.0 mm) copper pad areas

Typical Characteristics

FIG.1: FORWARD CURRENT DERATING CURVE

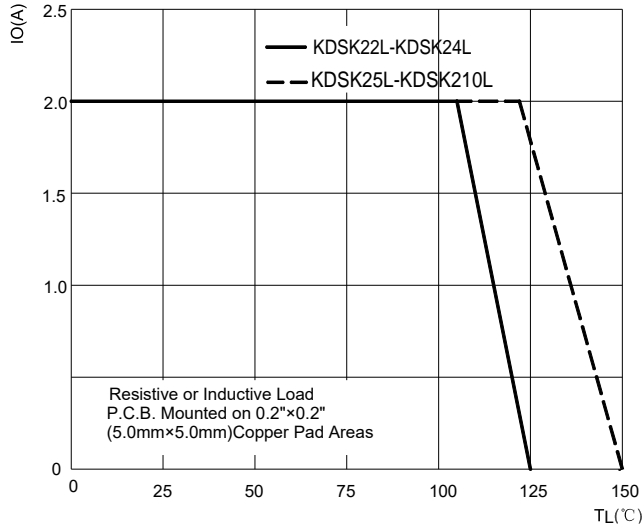

FIG.2: MAXIMUM NON-REPETITIVE FORWARD URGE CURRENT

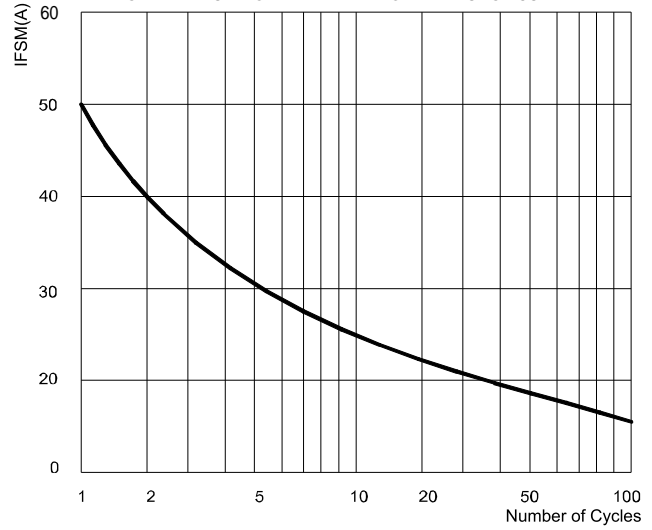

FIG.3: TYPICAL FORWARD CHARACTERISTICS

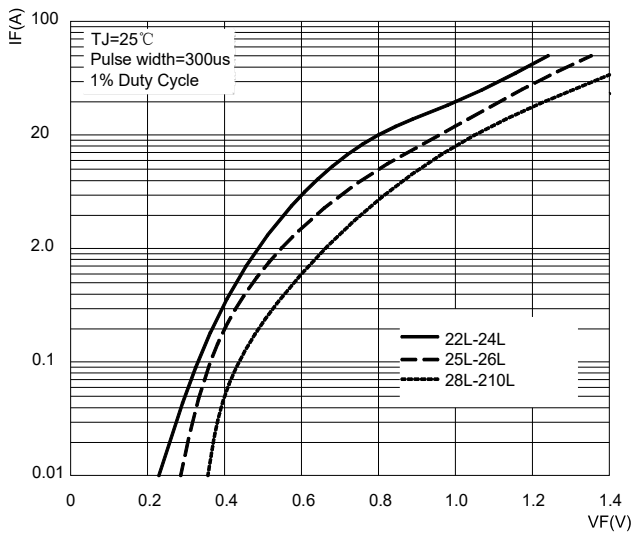
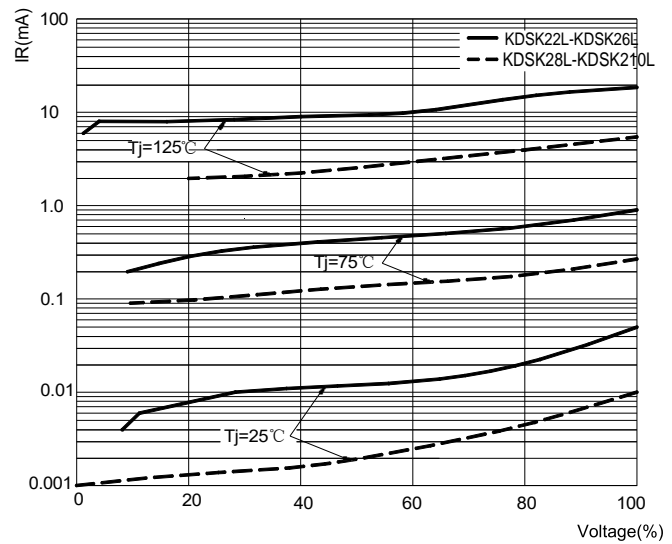
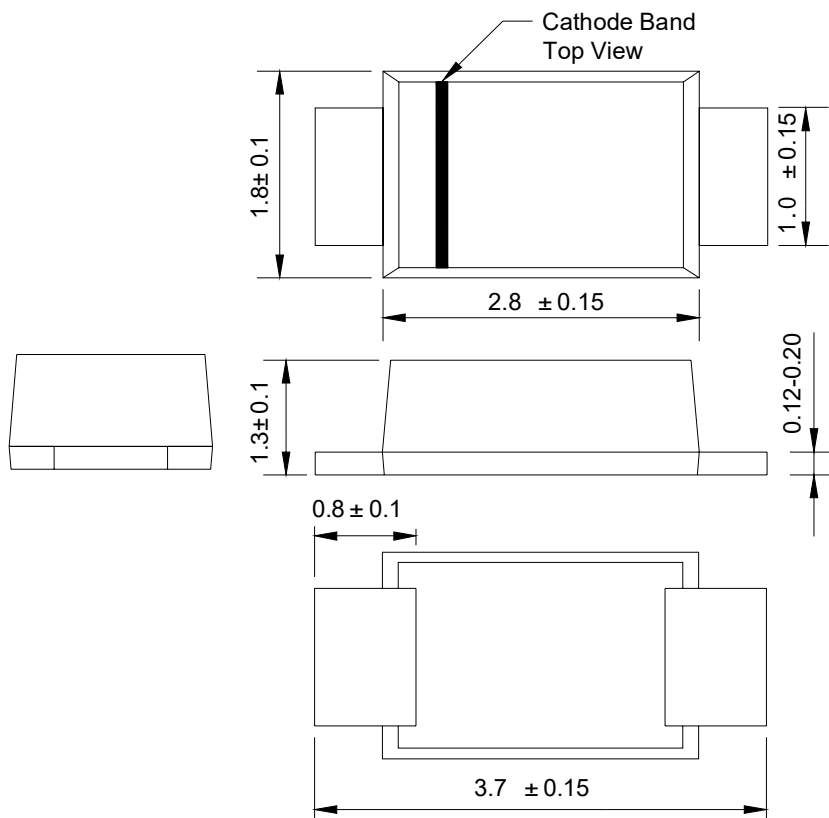

FIG.4: TYPICAL REVERSE CHARACTERISTICS



SOD-123FL Package Outline Dimensions



Dimensions in millimeters

SOD-123FL Suggested Pad Layout

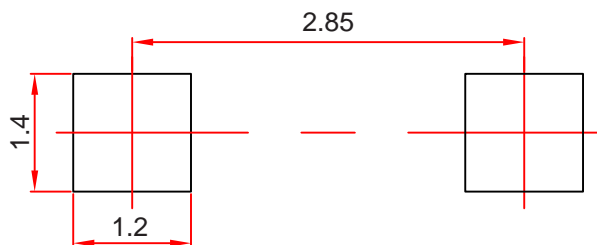

Note:

1. Controlling dimension: in millimeters.
2. General tolerance: ± 0.05 mm.
3. The pad layout is for reference purposes only.

Reel Taping Specifications For Surface Mount Devices-SOD-123FL

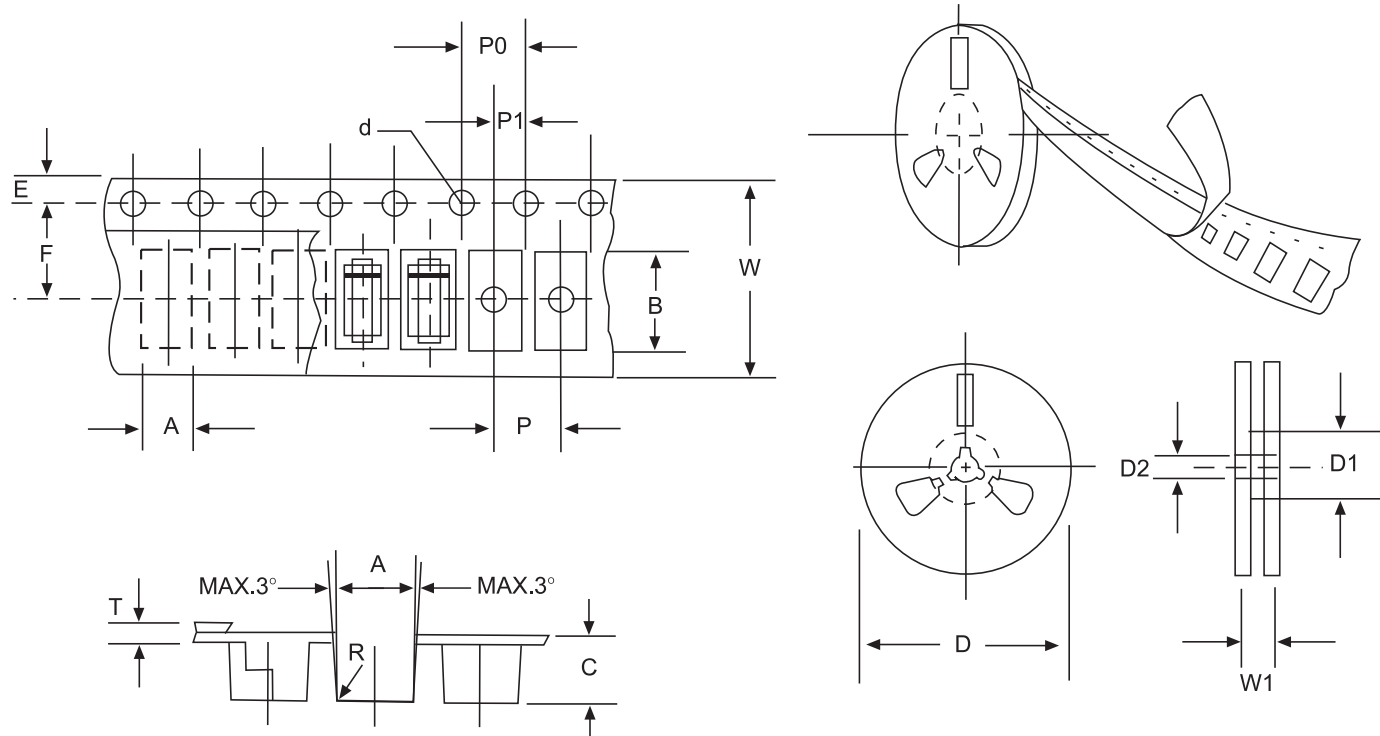

FIG: CONFIGURATION OF SURFACE MOUNTED DEVICES TAPING

ITEM	SYMBOL	SOD-123FLmm(inch)
Carrier width	A	2.05±0.1(0.081±0.004)
Carrier length	B	3.95±0.1(0.156±0.004)
Carrier depth	C	1.45±0.1(0.057±0.004)
Sprocket hole	d	1.55±0.05(0.061±0.002)
Reel outside diameter	D	178±2.0(7.0±0.079)
Reel inner diameter	D1	54±1.0(2.13±0.039)
Feed hole diameter	D2	13±0.5(0.512±0.020)
Sprocket hole position	E	1.75±0.1(0.069±0.004)
Punch hole position	F	3.50±0.1(0.138±0.002)
Punch hole pitch	P	4.0±0.1(0.157±0.004)
Sprocket hole pitch	P0	4.0±0.1(0.157±0.004)
Embossment center	P1	2.0±0.1(0.079±0.004)
Total tape thickness	T	0.21±0.25(0.008±0.010)
Tape width	W	8.0±0.2(0.315±0.008)
Reel width	W1	10.0±2.0(0.394±0.079)

NOTE: Devices are packed in accordance with EIA standard RS-481-A and specification given above.