

SOD-323 Plastic-Encapsulate Diodes

ZENER DIODE

Features:

- Planar Die Construction
- Ultra-Small Surface Mount Package
- General purpose, Medium Current
- Ideally Suited for Automated Assembly Processes
- Zener Voltage Tolerance: $\pm 2\%$

SOD-323

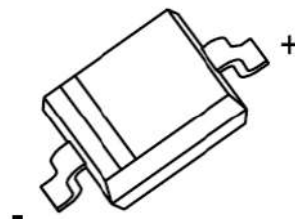

Maximum Ratings (Ta=25°C unless otherwise specified)

Characteristic	Symbol	Value	Unit
Forward Voltage (Note 2) @ I _F = 10mA	V _F	0.9	V
Power Dissipation(Note 1)	P _d	500	mW
Thermal Resistance, Junction to Ambient Air	R _{θJA}	625	°C/W
Operation Junction and Storage Temperature Range	T _J , T _{stg}	-55~+150	

Notes: 1. Device mounted on ceramic PCBS; 7.6 mm x 9.4 mm x 0.87 mm with pad areas 25 mm².
 2. Tested with pulses, T_p ≤ 1.0ms.

ELECTRICAL CHARACTERISTICS

T_a=25°C unless otherwise specified

Type Number	Code	Zener Voltage Range (Note 2)			Test Current	Maximum Zener Impedance		Maximum Reverse Leakage Current	
		V _Z @I _{ZT}				I _{ZT}	Z _{KT} @I _{ZT}	Z _{ZK} @I _{ZK} =0.25mA	I _R
		Nom(V)	Min(V)	Max(V)	mA				
MMSZ5221CS	2C1	2.4	2.35	2.45	20	30	1200	100	1.0
MMSZ5223CS	2C3	2.7	2.65	2.75	20	30	1300	75	1.0
MMSZ5225CS	2C5	3	2.94	3.06	20	30	1600	50	1.0
MMSZ5226CS	2G1	3.3	3.23	3.37	20	28	1600	25	1.0
MMSZ5227CS	2G2	3.6	3.53	3.67	20	24	1700	15	1.0
MMSZ5228CS	2G3	3.9	3.82	3.98	20	23	1900	10	1.0
MMSZ5229CS	2G4	4.3	4.21	4.39	20	22	2000	5.0	1.0
MMSZ5230CS	2G5	4.7	4.61	4.79	20	19	1900	5.0	2.0
MMSZ5231CS	2E1	5.1	5.00	5.20	20	17	1600	5.0	2.0
MMSZ5232CS	2E2	5.6	5.49	5.71	20	11	1600	5.0	3.0
MMSZ5233CS	2E3	6.0	5.88	6.12	20	7	1600	5.0	3.5
MMSZ5234CS	2E4	6.2	6.08	6.32	20	7	1000	5.0	4.0
MMSZ5235CS	2E5	6.8	6.66	6.94	20	5	750	3.0	5.0
MMSZ5236CS	2F1	7.5	7.35	7.65	20	6	500	3.0	6.0
MMSZ5237CS	2F2	8.2	8.04	8.36	20	8	500	3.0	6.5
MMSZ5238CS	2F3	8.7	8.53	8.87	20	8	600	3.0	6.5
MMSZ5239CS	2F4	9.1	8.92	9.28	20	10	600	3.0	7.0
MMSZ5240CS	2F5	10	9.80	10.20	20	17	600	3.0	8.0
MMSZ5241CS	2H1	11	10.78	11.22	20	22	600	2.0	8.4
MMSZ5242CS	2H2	12	11.76	12.24	20	30	600	1.0	9.1
MMSZ5243CS	2H3	13	12.74	13.26	9.5	13	600	0.5	9.9
MMSZ5244CS	2H4	14	13.72	14.28	9.0	15	600	0.1	10
MMSZ5245CS	2H5	15	14.70	15.30	8.5	16	600	0.1	11
MMSZ5246CS	2J1	16	15.68	16.32	7.8	17	600	0.1	12
MMSZ5248CS	2J3	18	17.64	18.36	7.0	21	600	0.1	14
MMSZ5250CS	2J5	20	19.60	20.40	6.2	25	600	0.1	15
MMSZ5251CS	2K1	22	21.56	22.44	5.6	29	600	0.1	17
MMSZ5252CS	2K2	24	23.52	24.48	5.2	33	600	0.1	18
MMSZ5253CS	2K3	25	24.50	25.50	5.0	35	600	0.1	19
MMSZ5254CS	2K4	27	26.46	27.54	5.0	41	600	0.1	21
MMSZ5255CS	2K5	28	27.44	28.56	4.5	44	600	0.1	21
MMSZ5256CS	2M1	30	29.40	30.60	4.2	49	600	0.1	23
MMSZ5257CS	2M2	33	32.34	33.66	3.8	58	700	0.1	25
MMSZ5258CS	2M3	36	35.28	36.72	3.4	70	700	0.1	27
MMSZ5259CS	2M4	39	38.22	39.78	3.2	80	800	0.1	30

Typical Characteristics

Notes: Our company currently provide 5.1 V - 20 V products only

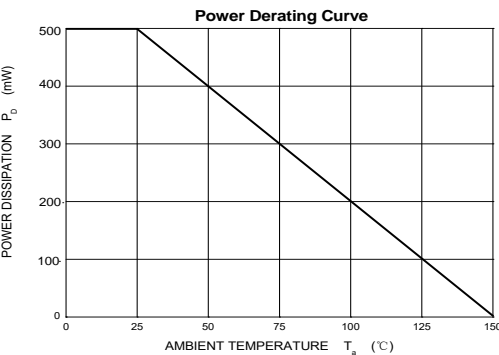
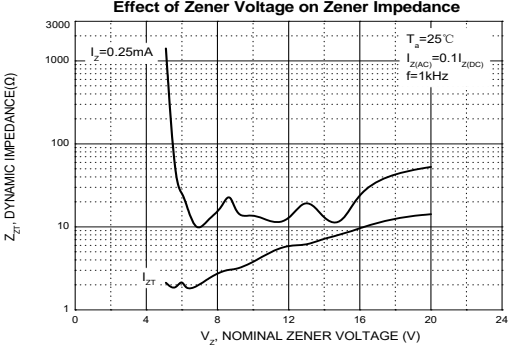
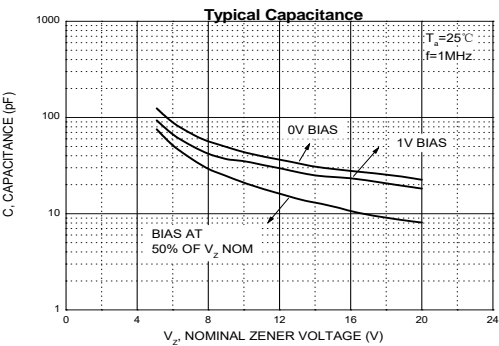
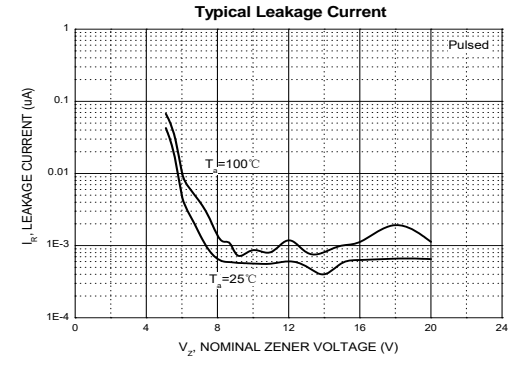
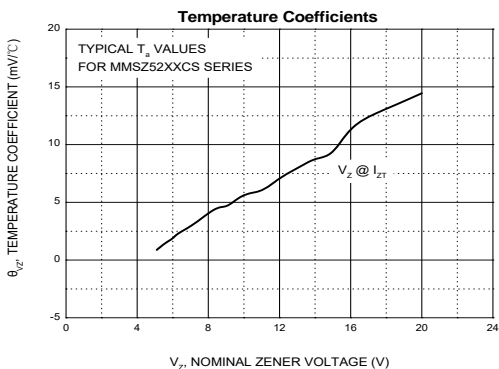
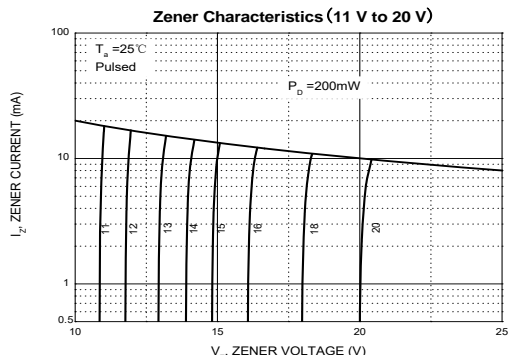
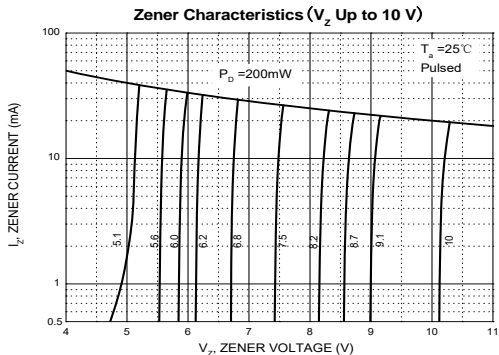

SOD-323 Package Outline Dimensions

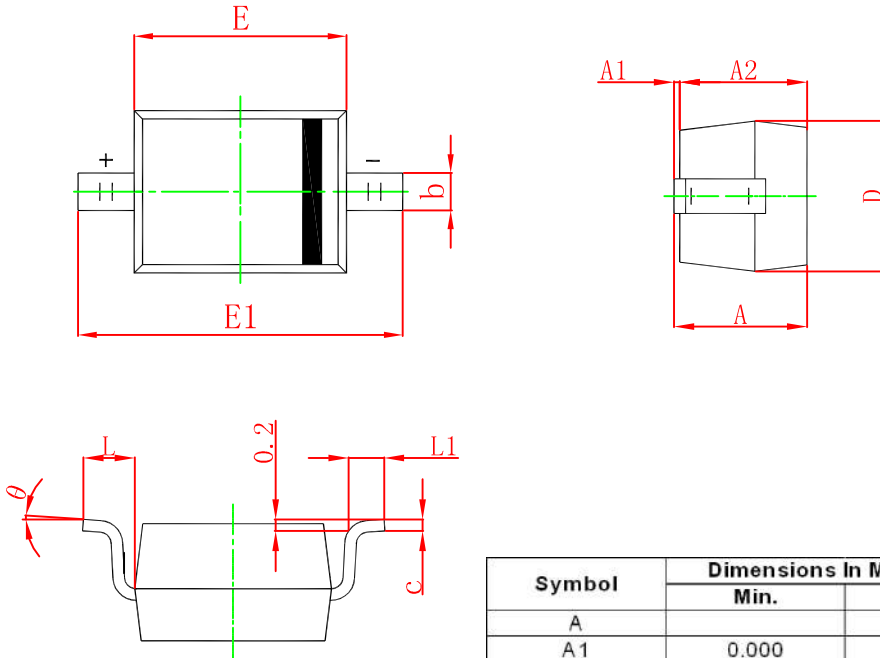

Symbol	Dimensions In Millimeters		Dimensions In Inches	
	Min.	Max.	Min.	Max.
A		1.000		0.039
A1	0.000	0.100	0.000	0.004
A2	0.800	0.900	0.031	0.035
b	0.250	0.350	0.010	0.014
c	0.080	0.150	0.003	0.006
D	1.200	1.400	0.047	0.055
E	1.600	1.800	0.063	0.071
E1	2.550	2.750	0.100	0.108
L	0.475 REF.		0.019 REF.	
L1	0.250	0.400	0.010	0.016
θ	0° - 8°		0° - 8°	

SOD-323 Suggested Pad Layout

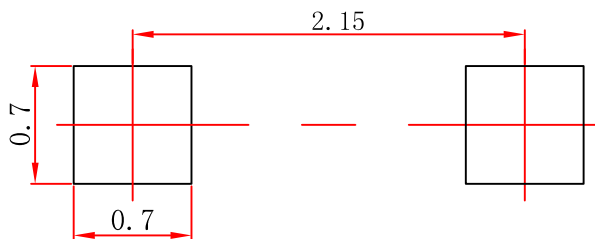

Note:

1. Controlling dimension: in millimeters.
2. General tolerance: $\pm 0.05\text{mm}$.
3. The pad layout is for reference purposes only.

SOD-323 Tape and Reel

SOD-323 Embossed Carrier Tape

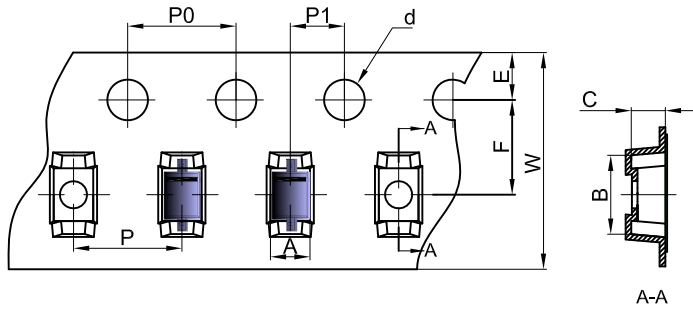

Packaging Description:
 SOD-323 parts are shipped in tape. The carrier tape is made from a dissipative (carbon filled) polycarbonate resin. The cover tape is a multilayer film (Heat Activated Adhesive in nature) primarily composed of polyester film, adhesive layer, sealant, and anti-static sprayed agent. These reeled parts in standard option are shipped with 3,000 units per 7" or 17.8cm diameter reel. The reels are clear in color and is made of polystyrene plastic (anti-static coated).

Dimensions are in millimeter										
Pkg type	A	B	C	d	E	F	P0	P	P1	W
SOD-323	1.48	3.3	1.25	Ø1.50	1.75	3.50	4.00	4.00	2.00	8.00

SOD-323 Tape Leader and Trailer

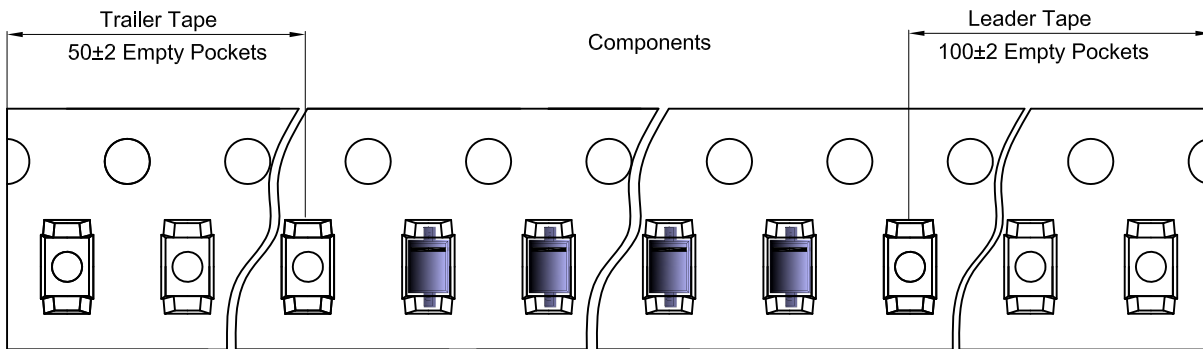

SOD-323 Reel

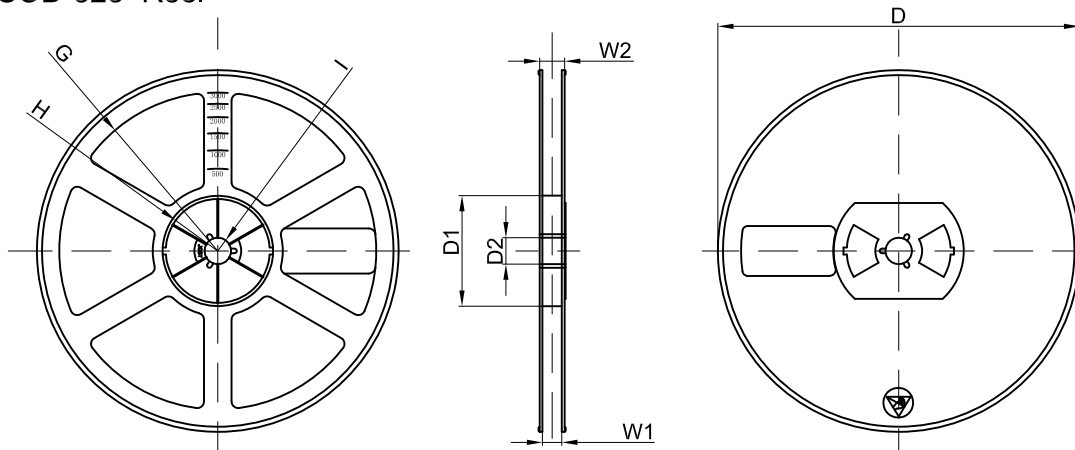

Dimensions are in millimeter								
Reel Option	D	D1	D2	G	H	I	W1	W2
7" Dia	Ø178.00	54.40	13.00	R78.00	R25.60	R6.50	9.50	12.30

REEL	Reel Size	Box	Box Size(mm)	Carton	Carton Size(mm)	G.W.(kg)
3000 pcs	7 inch	45,000 pcs	203×203×195	180,000 pcs	438×438×220	